

# Solid State Relay

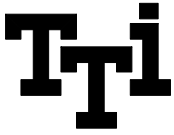

# SDD

DC Control DC

## MAIN FEATURES

- DC Voltage Drive DC loading SSR
- High Stable Reliability
- Non Switching Sparks
- Non Noise
- Non Mechanical Contact
- Low control Power Consumption
- High Speed Reaction

## APPLICATIONS

- Industrial Control Systems
- Lighting Systems
- Vending Machines
- Production Systems
- Temperature Control Systems
- Electronics Home Appliances
- Medical Equipment
- Conveying Systems



## ORDERING INFORMATION

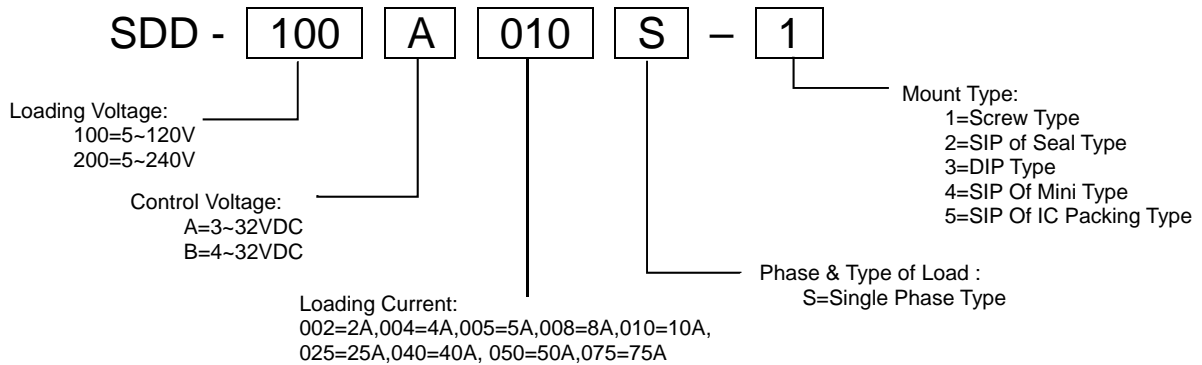

## OUTLINE DIMENSION (unit:mm)

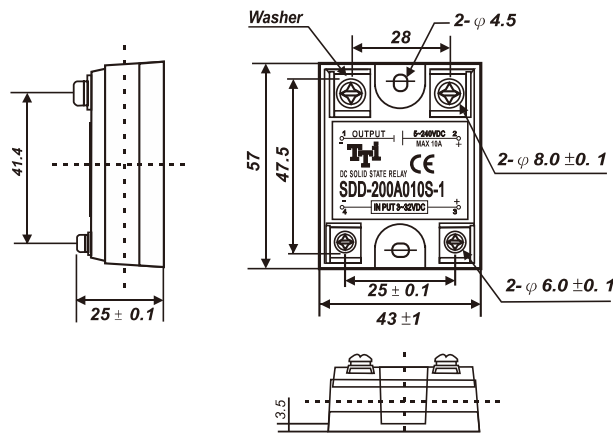

# Solid State Relay

## SPECIFICATIONS

<b>MODEL NO.</b>		SDD-100A005S-1	SDD-200A010S-1
		SDD-100A010S-1	SDD-200A025S-1
		SDD-100A025S-1	SDD-200A040S-1
		SDD-100A040S-1	SDD-200A050S-1
		SDD-100A050S-1	SDD-200A075S-1
		SDD-100A075S-1	
<b>MOUNT TYPE</b>		Screw Type	
<b>PHASE</b>		Single Phase	
<b>TYPE OF LOAD</b>		NA	
<b>INPUT</b>	<b>Control Voltage Range</b>	5~32VDC	4~32VDC
	<b>Must Turn Off Voltage</b>	MAX. 1VDC	
	<b>Input Impedance</b>	1.5 K $\Omega$	
<b>OUTPUT</b>	<b>Max. Load Current</b>	5A,10A,25A,40A,50A,75A	10A,25A,40A,50A,75A
	<b>Load Voltage Range</b>	5~120VDC	5~240VDC
	<b>Min. Blocking Voltage</b>	140VDC	300VDC
	<b>Max. Off-State Leakage</b>	Less 2mA	Less 3mA
	<b>Max.1 cycle Peak Surge</b>	25A,50A,100A, 200A,250A,375A	50A,100A, 200A,250A,375A
	<b>Max. Off State dv/dt</b>	500V/ $\mu$ sec	1000V/ $\mu$ sec
<b>GENERAL RATING</b>	<b>Isolate Impedance</b>	1G $\Omega$	
	<b>Dielectric Strength</b>		
	<b>Input-Output</b>	4000VAC RMS	
	<b>Input , Output-Case</b>	4000VAC RMS	
	<b>Turn On Time</b>	Less 2 ms	
	<b>Turn Off Time</b>	Less 2 ms	
	<b>Frequency Range</b>	47~70Hz	
	<b>Operating Temperature</b>	-20~+80 $^{\circ}$ C	
<b>Switching Type</b>	NA		
<b>Weight (g)</b>		100g	
<b>Compliance</b>		CE , RoHS	

## CHARACTERISTIC CURVES

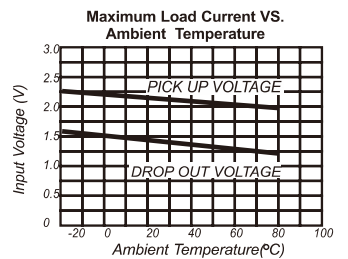
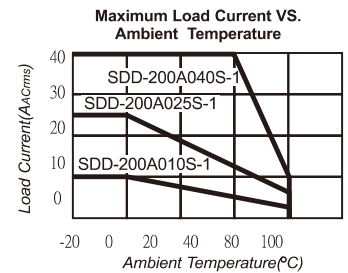
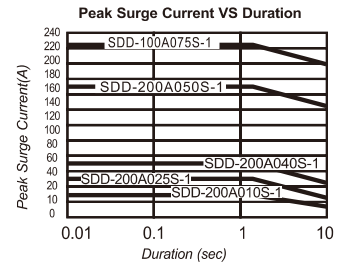
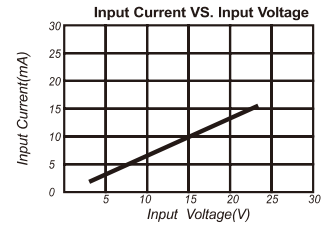

## EQUIVALENT CIRCUIT

